



Luxury
Redefined





We are a 1.25 Billion USD conglomerate in the electrical sector with a presence in over 90+ countries globally and a brand synonymous with Quality, Safety & Trust. Spread across multiple business verticals including Wiring Devices, RR Global has always endeavoured to create products of the highest quality using the latest in innovative technology.

Our vast range of Switches, Sockets, Modular Switch Plates & Accessories for both home & office use are crafted with seamless precision and meticulous attention to detail and adhere to the highest international safety standards, ensuring you get only the most efficient, reliable, and long-lasting products at the most competitive price.

Our products are RoHS compliant and tested for over 3 Lakh operations and come in a variety of colours and materials including Wood, Chrome, Metal, Leather amongst others. Come, experience the finest range of Switches that money can buy.

CONNECT

Our most premium range of modular switch plates, switches and accessories made from strong, sturdy materials that are easy to install. After extensive market wide research we have developed a set of wiring devices that you need at a price you are ready to pay that will in turn enhance the look and feel of your home or office. Make it magnificent with our Connect Range.



LONG OPERATIONAL LIFE



ENHANCED SAFETY



RoHS COMPLIANT



STRONG & STURDY
PROVIDING ROBUST FUNCTIONALITY



CONFORMING TO LATEST
IS STANDARDS



TESTED FOR 3 LAKH
OPERATIONS



EASY INSTALLATION



RETROFIT COMPATIBILITY

NATURA

An exquisite range of Premium Modular Plates, inspired by elements around us. Crafted to perfection keeping in mind safety norms, the natura series of switches is what your wall needs. In the office or at home, surround yourself with luxury. Choose from a wide range of Metallic, Leather, Toughened Glass and Wood plates.



Made using Natural Elements



Solid Polyamide encased Steel Frame



Precision Engineered Manufacturing



LED Beacon Night-time Locator

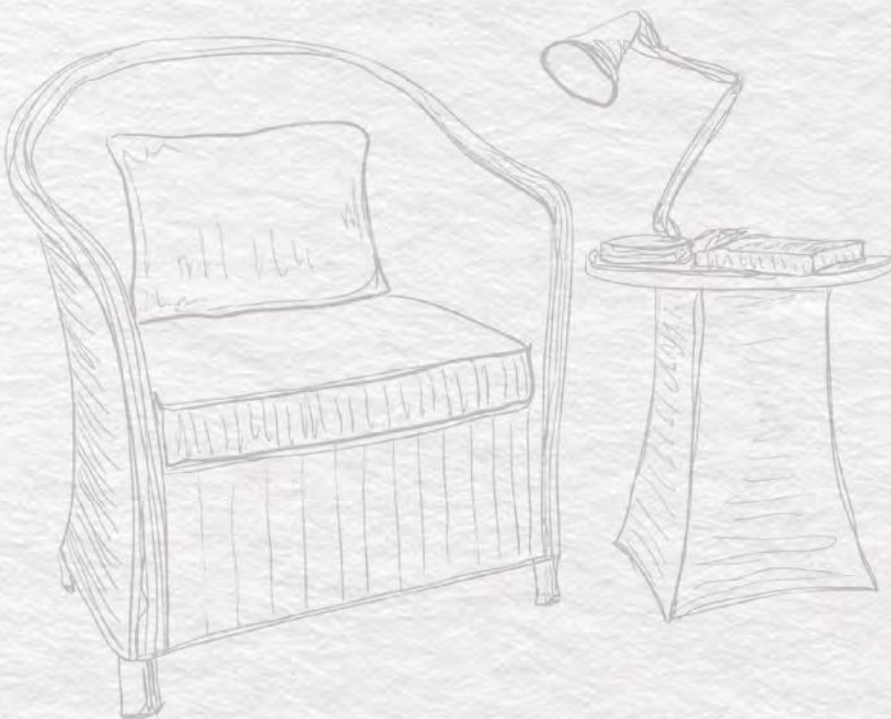

WOOD

Nature inspires us. She inspires us to do better, develop ingenious products that are safe, easy to use, long lasting and attractive. Presenting the Wood Series of Modular plates. Match the best of nature with our authentic wood finished Products.



Rustic Timber



American White Oak

GLASS

Our toughened glass cover plates are elegant and sturdy at the same time and send out a statement to your guests, emphasizing a home décor that does not compromise on safety and quality. These glass plates can be complemented by our collection of switches and accessories for an ideal fit.



Crystal White



Crystal Black

LEATHER

Designed for the style conscious, our leather series plates are sturdy and long lasting made from high grade polycarbonate material. A perfect mix of style and quality that is easy to clean and perfect for any interior.



Croco Leather

METAL

The perfect alternative to the traditional white colored Plates. Our Metallic finish plates are strong, sturdy with an exquisite metallic feel available in multiple colors suitable for any wall. This is your perfect upgrade.



Aluminio



Lustro Brown



Rose Gold

LUSH

Imagine a world full of colour and vibrancy, of various textures and designs. Bring this world to your home and decorate your walls with our Lush series of plates. Choose from a wide variety of Colour, Wood or even Marble finish plates that are long lasting, peel proof and scratch resistant.



A Palette of Colours & Textures.



Premium Polymer friendly pigments

(that are long lasting, peel proof, scratch & abrasion resistant).

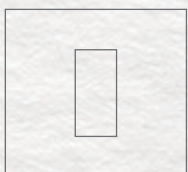

1M Plate

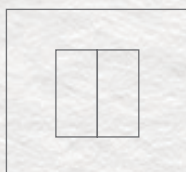

2M Plate

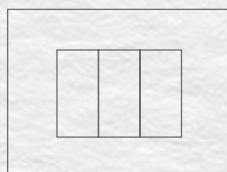

3M Plate

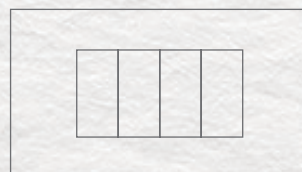

4M Plate

Plates Available till 18 Modules

COLOUR

The colour range of plates are feature-rich, colourful and thoughtfully designed, delivering superior aesthetics and greater durability. With a perfect shine, higher resistance to damage and fading and excellent consistency, bring a spark of colourful change to your home or office. Choose from an extensive range of colors like gold mist, dark brown, pearl black, pastel blue to name a few.



Pearl Black



Magnesium grey



Dark Brown



Gold Mist



Pearl Aluminium



Pastel Blue



Matte Beige



Matte Green

WOOD

Bring nature home with our exclusive wood collection. Choose from Birch, Walnut or Rose wood all made with the strongest, most durable materials with the highest safety standards. Now, decorate your walls safely and elegantly.



Birch Wood



Walnut Wood



Rose Wood

MARBLE

Made from 100% authentic, high-quality real natural stone materials, our extensive switch plate cover collection will help you bring natural elements into your home. These pieces will perfectly complement your bath and kitchen walls while allowing you to finish up your projects without any compromises.



Calcite White Marble



Picasso Black Marble

WUNDER

Colour your world the way you like with our 'Design-Your-Own' Modular Switch Plates from RR. A wide range of high-quality modular plates with UV Protection for longer life & fresh look to decorate your home or office the way your like. Mix & match, splash, write, brush the shades of your choice by bringing out the artist in you.

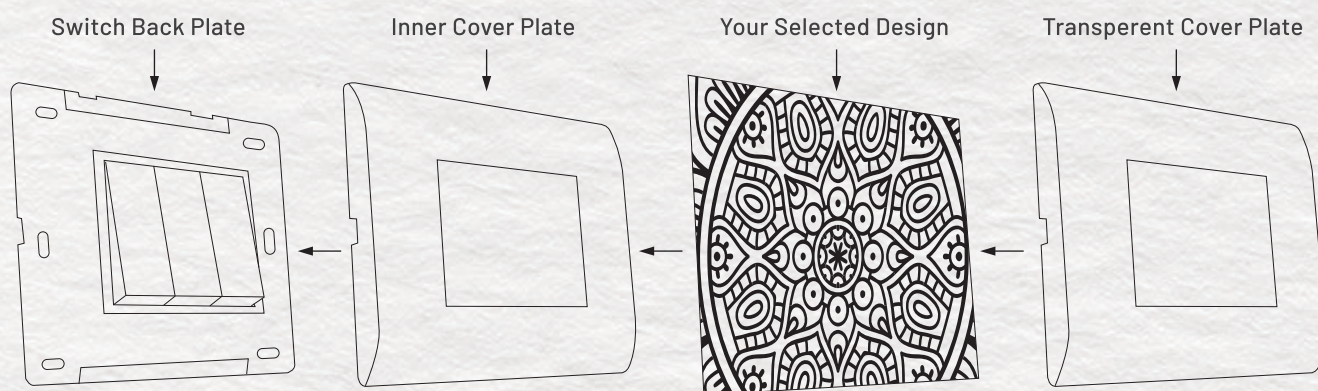

SUPERWHITE

White goes with everything. Quite literally. Our Super White modular switch plates made of DRC technology for longer life, dirt resistant design and Spark Shield for enhanced safety is the perfect fit to go classic. Keep it simple, yet chic with Superwhite modular switch plates.

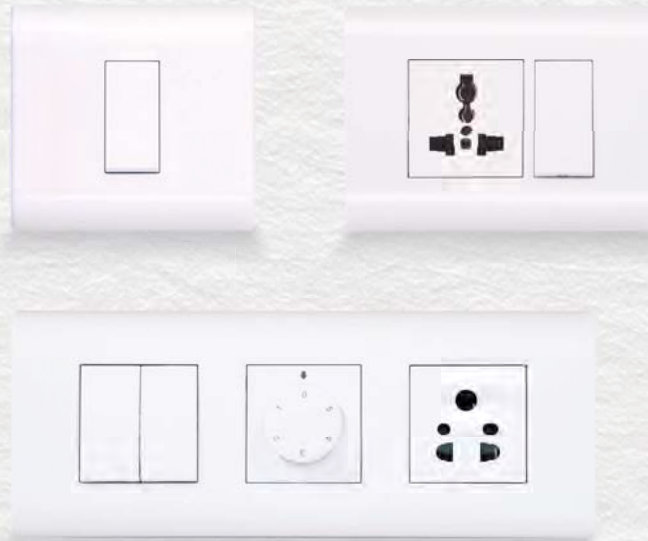

Superwhite



DRC Technology for longer life



Captive screw & Dirt Resistant design



Spark Shield for enhanced safety



Tested for more than 3 Lakh Operations

HOSPITALITY

Offering quality solutions for the hospitality industry. Our vast range covers your every requirement, from a slick shaver-socket, electronic key-tags to motion-sensor lights and mood-enhancing foot lights. This uber chic range is designed to add life and convenience to hospitality. We go the extra mile with our bespoke offerings for large and personal requirements.



SKIRTING LIGHT



SHAVER SOCKET



KEY TAG SWITCH



MOVEMENT DETECTOR

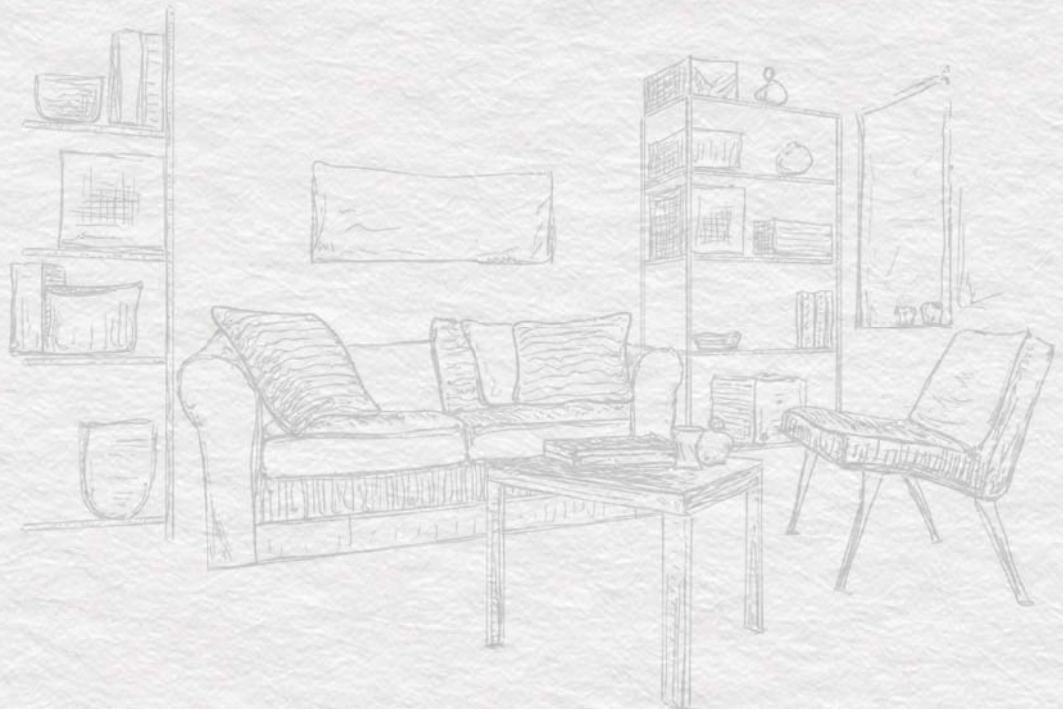

ACCESSORIES



10 AMPS 1 WAY



10 AMPS 1 WAY
WITH INDICATOR



10 AMPS 2 WAY



10 AMPS BELL PUSH
WITH IND. -2 M



32 AMPS DP WITH
INDICATOR



STEP TYPE
FAN REGULATOR
100 W



FAN REGULATOR 100 W
360 ROTATION



DIMMER - 200 W



DIMMER - 400 W



6 AMP ELEVATED SOCKET



6 / 16 AMPS COMB. SOCKET



3A USB CHARGER
SOCKET - 2 PORT



6 AMPS
2 PIN SOCKET

SOCKETS



Phosphor Bronze contacts



Sockets are Tested for more than 10k cycles



Longer Service life, Lower Power loss



Consistent contact pressure

REGULATORS



4 Nos of Safety Capacitors. - Wide range to offer

OPEN VIEW OF ONE WAY SWITCH

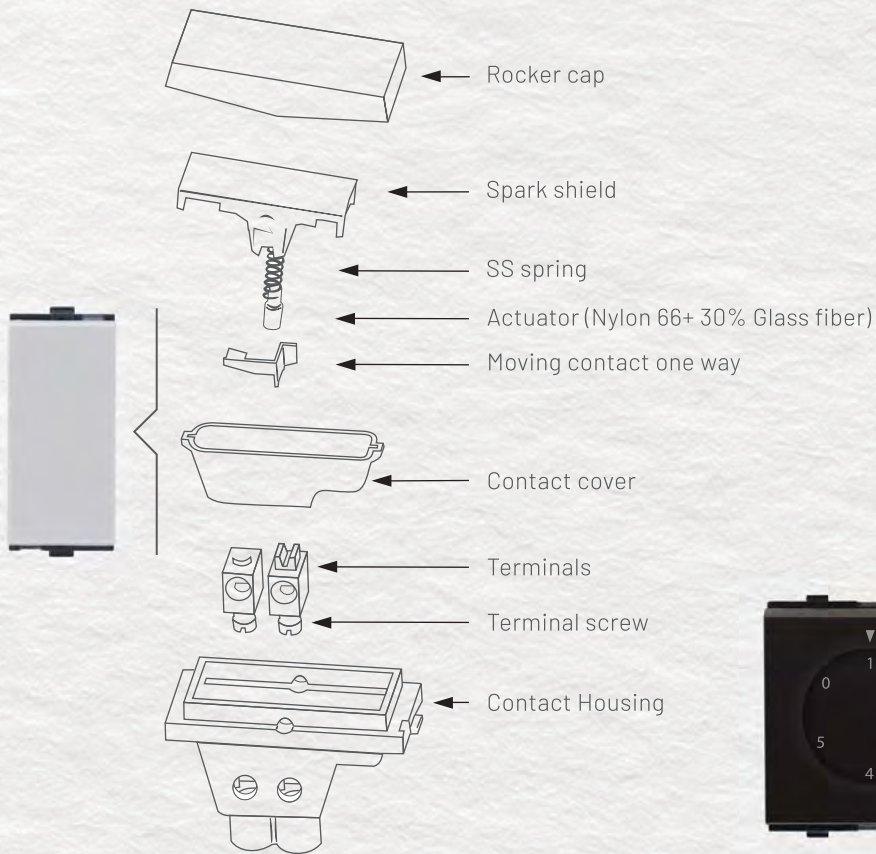

BACK OF REGULATOR

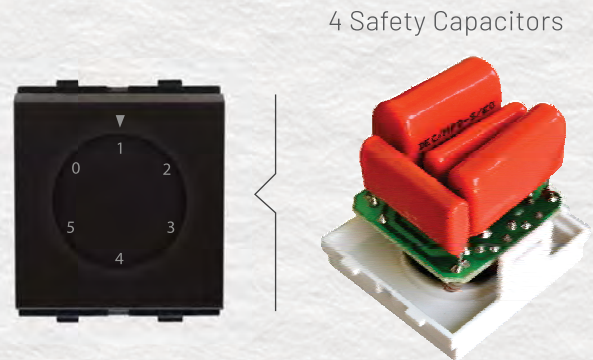

OPEN VIEW OF SOCKET

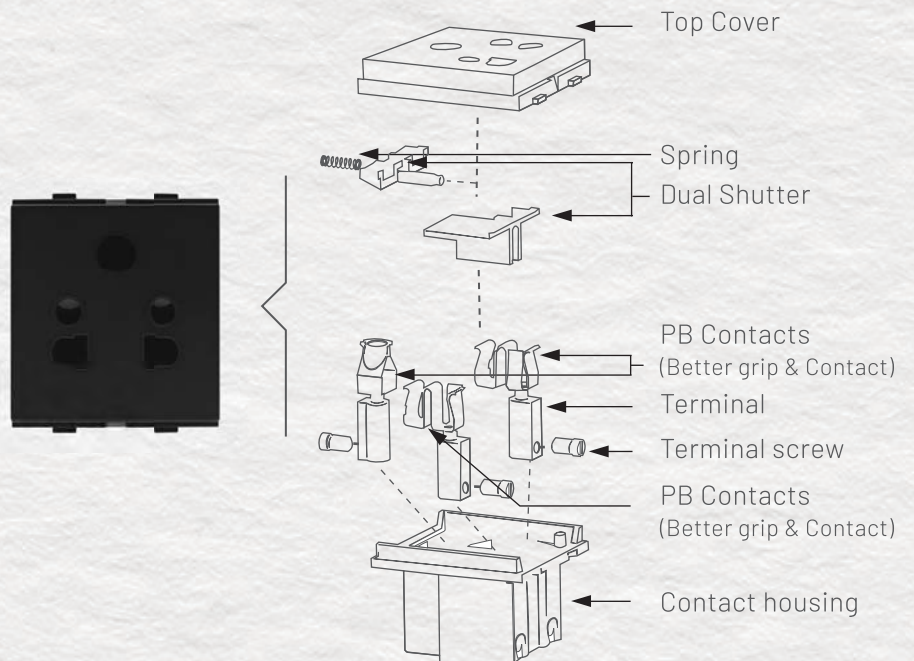

MAVEN

A new range giving a fresh new perspective on the simple switch with an uncompromising commitment to quality and safety. Researched and Developed in our state-of-the-art manufacturing unit, we ensure our products go through rigorous quality checks before they adorn your walls. We don't just make switches, we craft them to perfection.



LONG OPERATIONAL LIFE



ENHANCED SAFETY



RETROFIT COMPATABILITY
FOR EASY UPGRADE



ROBUST FUNCTIONALITY



CONFORMING TO LATEST
IS STANDARDS



STRONG AND STURDY
MOUNTING PLATES



HORIZONTAL & VERTICAL
MOUNTING PLATES



EASY INSTALLATION



SIMPLE & ELEGANT

KROMO

Cover all the switches and sockets of your home giving them a sophisticated look with these decor friendly chrome line switch plates. These plates assure safety from electric shocks, while providing a flair of elegance to the switches in your room. Available in different shapes and sizes, these cover plates suit all kind of sockets and switches.



Chrome White



Premium Foil Stamped Metallic Boarded front plates.



Peel Proof, Scratch & Abrasion Resistant

- Premium Foil Stamped Metallic Boarded front plates.

KROMO+

Chic and sophisticated, these polished chrome switch plates and outlet covers will add shine to any room of your home with their elegant mirror finish surfaces. Particularly popular with retro chrome kitchen hardware, mirrored bedroom furniture, and shiny silver bathroom fixtures, these quality wall plates are available in a wide range of sizes.



Chrome Black



Chrome Grey



Premium Foil Stamped Metallic Boarded front plates.



A Palette of Colours & Textures.



Premium Polymer friendly pigments



Peel Proof, Scratch & Abrasion Resistant

- Premium Foil Stamped Metallic Boarded front plates.

COLOR

Add a splash of colour to your home. Introducing colourful switch plate covers for all your wiring devices. At RR, we want our users to live the advantage. We have an array of switch plate covers, suitable for various interior design needs. Selecting the best switches for your house is now easier than ever, choose from an extension variety including Midnight Black, Metallic Grey, Berry Red, Maple Wood, Smoked Walnut to name a few.



Midnight Black



Metallic Grey



Natural Silver



Metallic Gold



Fern Green



London Blue



Aluminium



Sand Beige



Berry Red



Maple Wood



Mahogany Wood



Smoked Walnut



Venetino Marble



A Palette of Colours & Textures.



Premium Polymer friendly pigments



Peel Proof, Scratch & Abrasion Resistant



WHITE

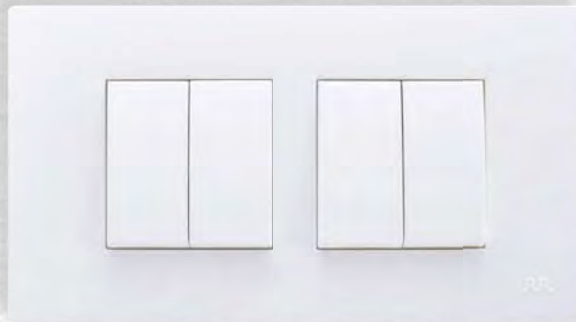
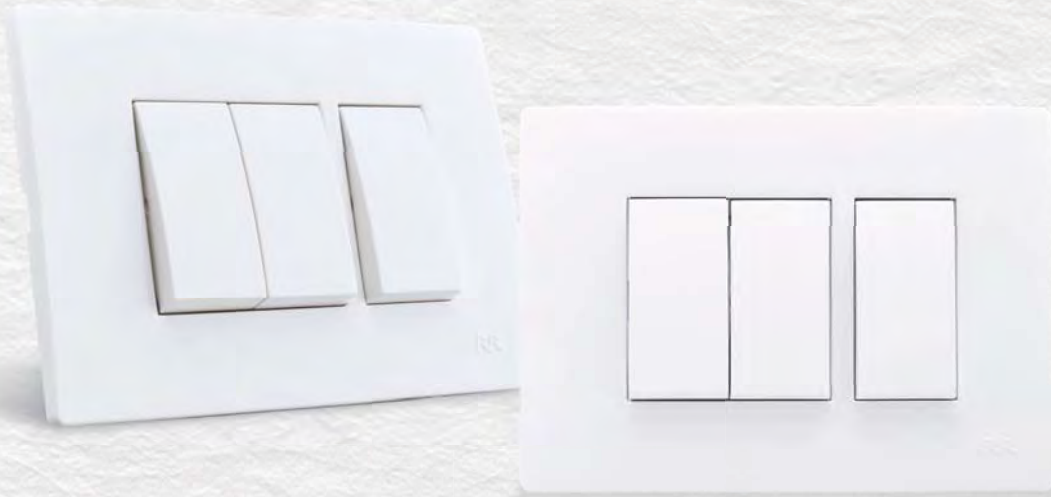

Horizontal Fitting

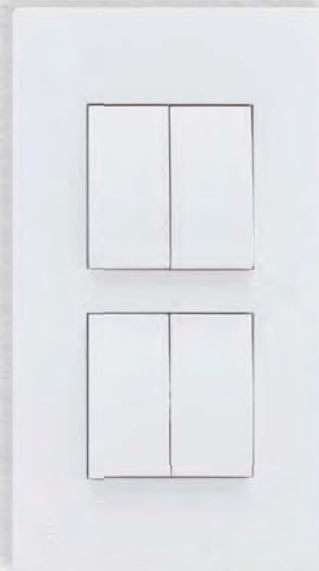

Vertical Fitting



APM Technology (Advance Plunger Mechanism)



Soft glow blue LED switch Indicators



Captive wiring screw



Tested for more than 3 Lakh Operations

MAVEN ACCESSORIES



10AX TWO
WAY SWITCH



10AX ONE WAY SWITCH
WITH INDICATOR



10A BELL PUSH



10A BELL PUSH WITH
INDICATOR



10A BELL PUSH 2M



STEP FAN REGULATOR
1M (4 SPEED)



STEP FAN REGULATOR
2M (5 SPEED)



LAMP DIMMER 500VA



LAMP DIMMER 1000VA



3A USB
CHARGER SOCKET



1 MODULE



2 MODULE

MINI MCB - IS:60898



Full Rotatory 360 degree break proof operating knob.



Energy saving 100% hum free fan regulators.



Optimum speed control option (100W & 50W)

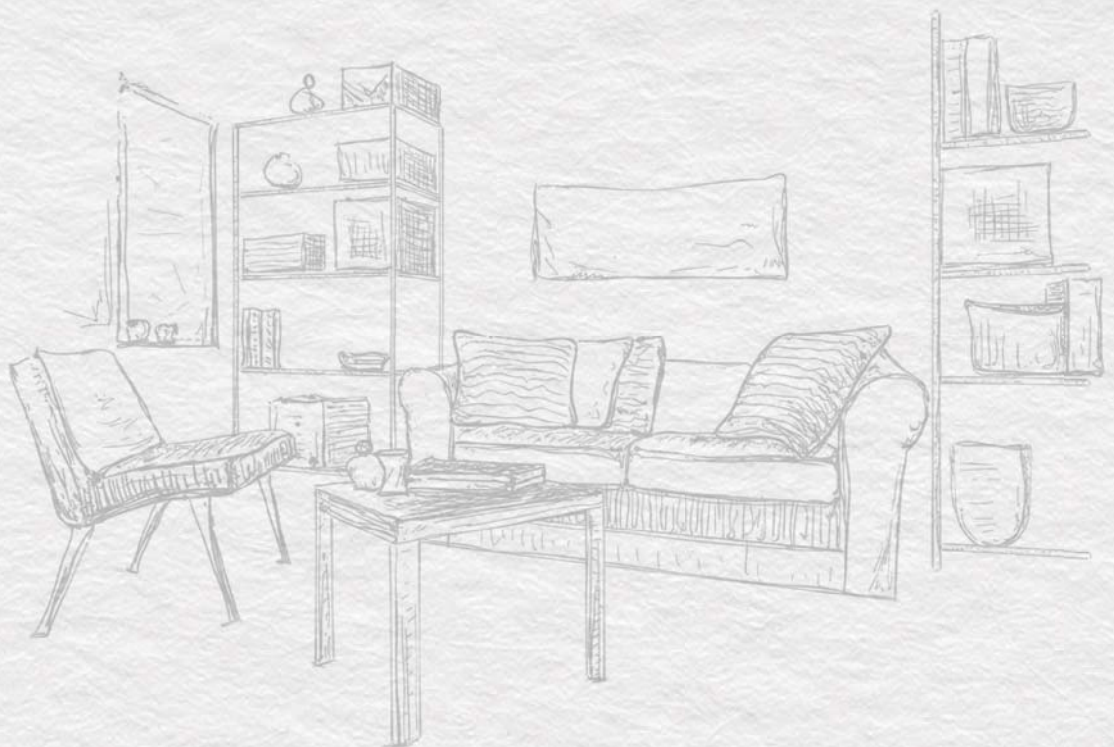

BOXES



GI Metal Boxes

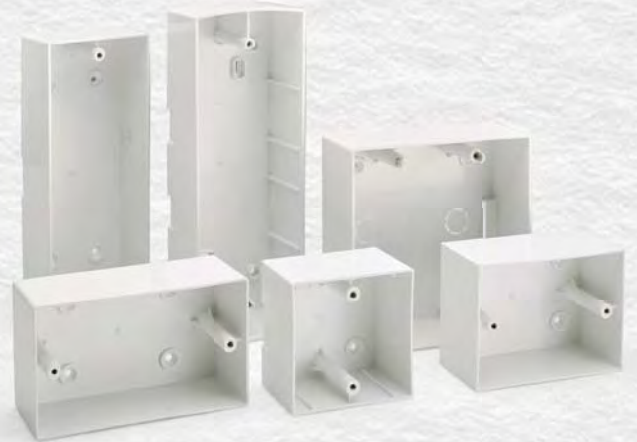

PVC Surface Boxes



GPSP Material Metal Boxes

- Single sheet design, No Joint & No welding
- Made of Pre-Galvanized Virgin sheet.
- Dedicated earthing point to avoid electric shock.
- Screw mounting hole comes with protection Locking Clip to cover for Cement / Dust protection.
- Available in Regular, 1 MM and 1.2 MM metal sheet

GENERAL ACCESSORIES



CORD LENGTH
1.50 MTR.



ROBUST & COMPACT
DESIGN



USB & Non USB
Options available



OVER VOLTAGE
PROTECTION



SHORT CIRCUITS
PROTECTION



FUSE
PROTECTION



POWER CONTINUITY
LED INDICATION



ANGLE HOLDER
REGULAR



BATTEN HOLDER
REGULAR



JUMBO CEILING ROSE
2 PART



JUMBO CEILING ROSE
3 PART



CEILING ROSE
2 PART



CEILING ROSE
3 PART



ANGLE HOLDER
PREMIUM



BATTEN HOLDER
PREMIUM



ANGLE HOLDER
SQUARE



SQUARE HOLDER
BATTEN



Ram Ratna House, Utopia City, P. B. Marg, Worli, Mumbai - 400 013.

T: +91 - 22 - 2494 9009 / 2492 4144 • **F:** +91 - 22 - 2491 2586 • **E:** mumbai.rrkabel@rrglobal.com

Alembic Business Park (W), Ground Floor, Bhailal Amin Marg, Gorwa, Vadodara - 390 003

T: +91-265-6830 800 • **E:** vadodara.rrkabel@rrglobal.com

R R KABEL LIMITED

Regd. Office : Ram Ratna House, Utopia City, P. B. Marg, Worli, Mumbai - 400 013.

Ahmedabad: 079 - 4900 0100, **Bengaluru:** 080 - 4125 0079 / 4090 2221, **Bhubaneswar:** 9776 060 012,
Chennai: 044 - 2829 2329 / 2429, **Coimbatore:** 9025 168 457, **Guwahati:** 0361 - 2730 772,
Indore: 0731 - 4108 517, **Jaipur:** 0141 - 2741417, **Jalandhar:** 0181 - 2910 637, **Ernakulam:** 0484 - 2378 783,
Kolkata: 033 - 6607 1233, **Lucknow:** 0522 - 3516 188/89, **Madurai:** 0452 - 4370 340,
New Delhi: 011 - 4303 8395 / 2735 5477 / 78, **Pune:** 8956 811 100, **Raipur:** 0771 - 4051 518,
Rajkot: 0932 7722 501, **Secunderabad:** 040 - 2780 4098, **Silvassa:** 0260 - 2641 333,
Sonipat: 0130 - 2986 986, **Surat:** 9376 507 543, **Trichy:** 0431 - 4540 363

www.rrglobal.com |     YouTube

Incase of Complaint contact Customer Care : customercare.wd@rrglobal.com or Call:1800 1036 633

RoHS = Restriction of Hazardous Substances | **CE** = Conformance Europeenne
ISI = Indian Standard Institution